

BALCO™

FPV HD

CAMERA DRONE



Model Number: HE180066

INSTRUCTION MANUAL

Important

Getting the most out of your Balco FPV HD Camera Drone:



Read the manual carefully

It will help you set up with ease



Visit www.balcolifestyle.com

We have additional support videos and guides



Call After Sales Support - 44 800 496 9698



Email customercare@balcolifestyle.com

We're always happy to help

Warranty Note

If you experience any issues with this product or its performance is not what you had expected, please contact us at Balco Lifestyle before returning the item to the store.

It is likely that we can resolve any problems for you via phone or email.

Safety Instructions

Follow all instructions and take notice of all warnings to reduce risk of fire or electric shock.

- Read the instructions in this manual thoroughly before operating your Balco FPV HD Camera Drone
- This drone must be operated safely at all times. It is the operator's responsibility to always fly in safe conditions
- Always check each component of the drone is operating correctly before flying
- Always follow local aviation rules and regulations when flying the drone
- This drone is designed for ages 14+
- Adult supervision is always advisable with any form of flying
- Always ensure your flight area is safe
- Always keep the drone in direct line of sight
- Do not immerse the drone, batteries nor the remote control in water
- If a problem occurs with the drone, always contact the supplier before attempting to fly again
- Do not fly in windy, rainy or low light conditions
- Non-rechargeable batteries are not to be recharged
- Rechargeable batteries are to be removed from the drone before being charged
- Rechargeable batteries are only to be charged under adult supervision
- Exhausted batteries are to be removed from the drone
- Danger of explosion if battery is incorrectly replaced. Replace only with the same or equivalent type of battery
- The supply terminals are not to be short-circuited
- Do not leave drone or batteries near a heat source such as fire or heater or in direct sunlight
- Keep the drone and batteries in a cool dry place
- Only use the provided charger to recharge the rechargeable battery
- The charger is for indoor use only
- If the device is exposed to sudden changes in temperature, for example when taken from the cold into a warm room, wait at least two hours before operating the drone

After Sales Support



44 800 496 9698



customercare@balcolifestyle.com

Model Number HE180066

Warnings

- This drone is not a toy and can cause severe damage or injury if used incorrectly. If you have never flown a drone before, read the full manual before attempting to fly
- Propellers are hazardous moving parts, when they are operational keep fingers and other body parts away from them
- Incorrect operation of the drone may result in severe injury, loss of property or fines. Balco Lifestyle does not take any responsibility if local rules and regulations are not followed
- **Balco Lifestyle does not take any responsibility for the loss of the Balco FPV HD Camera Drone and it is NOT covered by warranty.** We recommend that users test their drone in a safe indoor environment before attempting to fly the drone outdoors
- Do not attempt to repair, open or alter any components. In the case of improper usage or if you have opened, altered or repaired the product yourself, all warranties and guarantees are void.

After Sales Support



44 800 496 9698



customercare@balcolifestyle.com

Model Number HE180066

Rules & Regulations – UK

The following regulations must be followed when operating a camera drone or quadcopter in the United Kingdom.

- You must only operate this aircraft in your line-of-sight in daylight
- You must not fly closer than 150ft (50m) to people and property
- You must not fly over nor fly closer than 500ft (150m) to crowds and built up areas
- Every time you fly your drone you must follow the manufacturer's instructions
- Stay below 400ft (120m) at all times to reduce any conflict with manned aircraft
- Stay away from aircraft, airports and airfields at all times. If your drone endangers the safety of an aircraft, it is a criminal offence and you could go to prison for five years
- You are legally responsible for each flight and failure to fly responsibly could result in criminal prosecution

It is the user's responsibility to regularly check and abide by current rules & regulations. For further information, please refer to the flight regulations flyer included with your drone OR visit <http://dronesafe.uk>.

After Sales Support



44 800 496 9698



customercare@balcolifestyle.com

Model Number HE180066

Rules & Regulations – Ireland

The following regulations must be followed when operating a camera drone or quadcopter in the Ireland.

You should never operate your drone:

- If it will be a hazard to another aircraft in flight
- Over an assembly of people (e.g. concerts, sporting events, parades)
- Farther than 300 metres
- Within 30 metres of any person, vessel, vehicle or structure not under your direct control
- Closer than 5km from any aerodrome
- In a negligent or reckless manner so as to endanger life or property of others
- Over 400ft (120m) above ground level
- Over urban areas such as villages, towns and cities
- In civil or military controlled airspaces or any restricted areas
- Unless you have permission from the landowner for take-off and landing
- Outside of your direct line of sight

It is the user's responsibility to regularly check and abide by current rules & regulations. For further information, please refer to the flight regulations flyer included with your drone OR visit <http://www.iaa.ie/drones>

After Sales Support



44 800 496 9698



customercare@balcolifestyle.com

Model Number HE180066

Contents

Warranty Note	3
Safety Instructions	4
Warnings	5
Rules & Regulations – UK	6
Rules & Regulations – Ireland	7
Parts List	9
Features	9
Technical Specifications	9
Product Overview	10
1.1 Balco FPV HD Camera Drone	10
1.2 Remote Control	11
Setup & Installation	12
2.1 Installing the Remote Control Batteries	12
2.2 Charging & installing the Balco FPV HD Camera Drone Battery	12
2.3 Install the Camera and Propeller Guards	13
2.4 Installing the Phone Holder to use your Smartphone	13
Operation	14
3.1 Turning ON and Pairing the Remote Control with the Drone	14
3.2 Switching OFF the Propellers & Drone	15
3.3 Flying the Balco FPV HD Camera Drone	16
3.4 Fine Tuning / Trimming	17
3.5 Level Calibration	18
3.6 Speed Control	18
3.7 360° Flip Stunt Feature	18
3.8 Hovering Height Adjustment	19
3.9 Headless / Normal Modes	19
3.10 Recalibrate the Balco FPV HD Camera Drone	20
3.11 Capture Photos & Videos	20
3.12 Replacing Parts	20
3.13 Fly the Balco FPV HD Camera Drone using the 'Drone Go' App	21
Operation	22
3.14 'Drone Go' Application Interface	22
FAQs	23



Parts List

1x Balco FPV HD Camera Drone	4x AA Activ Energy Batteries
1x 2.4GHz Remote Control	4x Propeller Guards
1x USB Charging Cable	4x Landing Skids (On the drone)
1x Rechargeable Battery	4x Spare Blades
1x Phone Mount	1x Instruction Manual
1x Screwdriver	1x Getting Started Guide
1x Detachable HD 720P Camera	1x Warranty Card
	1 x Flight Safety Card



Features

High Definition (720P) camera records high quality video & photos

FPV (First Person View) wireless transmission to iOS or Android smartphone*

Hover feature and headless mode

Light yet robust construction

360 degree built-in flip stunt feature

4 channel 2.4GHz remote control

6-Axis Gyroscope for stability

*App Control support types

iOS(MAC) 8.0 , Android 4.1

Technical Specifications

Rechargeable Battery for Drone:	3.7V DC 500mA Lithium Battery
Charging time:	Approx. 130 minutes
USB Charger Input:	5V DC
Fly time:	6 - 8 mins in hovering mode
Frequency:	2.4GHz
Maximum radio-frequency power transmitted:	13.8dBm
Gyro:	6 Axis
Battery for Remote control:	4 X AA batteries (included)
Control Distance with Remote Control:	Up to 45 meters ⁺
Control Distance with Smart Phone:	Up to 25 meters ⁺

⁺ **NOTE: Strong magnetic fields could reduce working distance**



This product complies with EU WEEE Directive (2012/19/EU). This product bears a classification symbol for waste electrical and electronic equipment (WEEE).

This marking indicates that this product should not be disposed with other household wastes throughout the EU. To prevent possible harm to the environment or human health from uncontrolled waste disposal, recycle it responsibly to promote the sustainable reuse of material resources. To return your used device, please use the return and collection systems or contact the retailer where the product was purchased. They can take this product for environmental safe recycling.



Packaging materials of the product are manufactured from recyclable materials in accordance with our National Environment Regulations. Do not dispose of the packaging materials together with the domestic or other wastes. Take them to the packaging material collection points designated by the local authorities.



Hereby, Winplus Australasia declares that the radio equipment Balco FPV HD Camera Drone is in compliance with Directive 2014/53/EU and 2011/65/EU. The full text of the EU declaration of conformity is available at the following internet address: <https://balcolifestyle.com/download/HE180066-ECDOC.PDF>

After Sales Support

☎ 44 800 496 9698



customercare@balcolifestyle.com

Model Number HE180066

Product Overview

1.1 Balco FPV HD Camera Drone

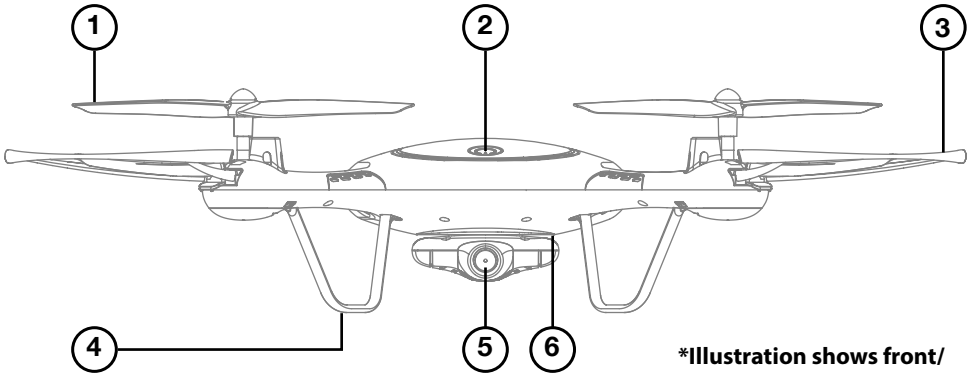

***Illustration shows front/
head of drone**

- | | | |
|--------------------|----------------------------------|---------------------|
| 1. Propeller | 4. Landing Skid | 6. Battery (Behind) |
| 2. ON/OFF Button | 5. Camera/SD Card Slot
(Rear) | |
| 3. Propeller Guard | | |

NOTE: SD Card not included. Maximum card capacity 32GB

After Sales Support

 44 800 496 9698

 customercare@balcolifestyle.com

Model Number HE180066

Product Overview

1.2 Remote Control

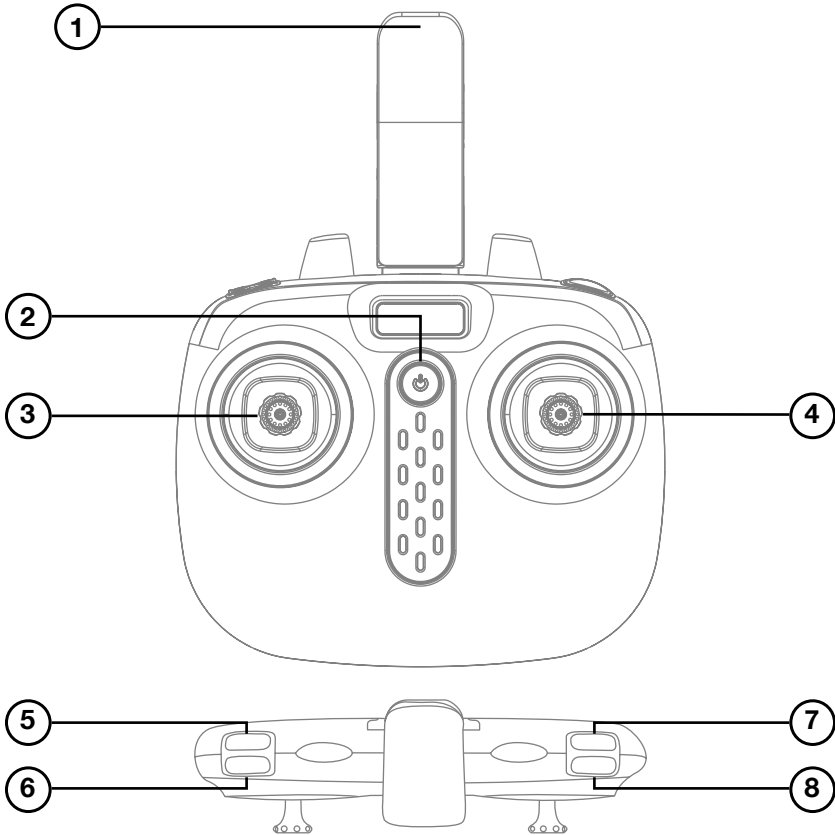

- | | | |
|---|--|--|
| <p>1. Phone Holder</p> <p>2. ON/OFF Button</p> <p>3. Left Thumb Stick - Fly Up/Down, Turn Left/Right, Depress for Fine Tuning,</p> | <p>4. Right Thumb Stick - Headless mode, Slow/Fast Speed Control, Fly Forwards/Backwards, Sideways Flying</p> | <p>5. Photo</p> <p>6. Video</p> <p>7. 360° Flip Stunt</p> <p>8. B Button - Short press for auto take off and landing</p> |
|---|--|--|

After Sales Support

 44 800 496 9698

 customercare@balcolifestyle.com

Model Number HE180066

Setup & Installation

2.1 Installing the Remote Control Batteries

- Use a screw driver to remove the screw on the back of the remote control, then open the battery cover
- Install the 4 x AA supplied batteries into the back of the remote control. Please note the polarity positions indicated
- Replace the cover and reinstall the screw

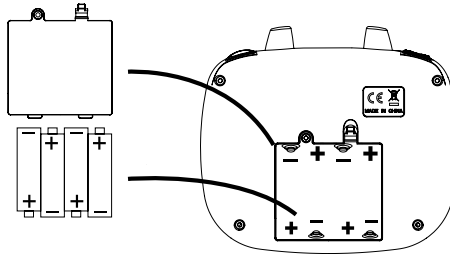

NOTE: For best performance, do not mix different types of batteries.

2.2 Charging & installing the Balco FPV HD Camera Drone Battery

- Fully charge the drone's battery before use
- Insert the battery power port into the small end of the supplied USB charging cable
- Insert the other end of the USB charging cable into a USB port (charger not included). The charging indicator light will be RED
- Once the charging indicator has turned OFF and no longer red, the battery is fully charged
- Disconnect the USB cable from the USB port
- Disconnect the battery power port from the small end of the USB charging cable
- Insert the battery into Balco FPV HD Camera Drone ensuring a tight fit



Setup & Installation

2.3 Install the Camera and Propeller Guards

- Connect the camera wires to the plug port located on the base of the drone. Coil any remaining cable into the cavity
- Insert the camera into the base of drone by twisting the camera 90 degrees into place until you feel a 'click' and some resistance



- Push the propeller guard into the slot and push the lever down until you hear a 'click'

NOTE:

- Ensure the camera is facing the head of the drone as illustrated on page 10. It should be facing away from the battery if you are looking at the drone's base
- To remove the camera, twist the camera 90 degrees to the right and unplug the wire

2.4 Installing the Phone Holder to use your Smartphone

If you are only using the remote control to operate the drone, you do not need to install the phone holder. It is ideal to use the phone holder when you want to use your smartphone to take photos and videos whilst still using the remote control to fly the drone.

To install the phone holder, turn the remote over and:

- Slide out the cover on the remote control as illustrated
- Insert the phone holder connector to the top of the remote control by sliding it down into place
- Press the ends of the phone holder to open and insert a smart phone. Release to secure device
- Ensure the device is secure before proceeding. Balco Lifestyle does not take any responsibility for devices that fall from the phone holder
- Press the ends of the phone holder to open & release device
- To remove the phone holder, press down on the moulded grooves at the back of the remote control and push up to release it



After Sales Support

44 800 496 9698



customercare@balcolifestyle.com

Model Number HE180066

Operation

WARNING: Incorrect operation of the Balco FPV HD Camera Drone may result in severe injury, loss of property or fines. Balco Lifestyle does not take any responsibility if local rules and regulations are not followed. Balco Lifestyle does not take any responsibility for the loss of the Balco FPV HD Camera Drone and it is NOT covered by warranty.

We recommend that users test their drone in a large, safe indoor environment before attempting to fly the drone outdoors. Do not fly above 3 metres until you can accurately and confidently control the Balco FPV HD Camera Drone.

3.1 Turning ON and Pairing the Remote Control with the Drone

To commence pairing, make sure you have switched both the remote control and drone ON by pressing the ON/OFF button on both devices. You will notice the ON/OFF buttons on both devices will flash red. To pair:

- a. Move the left thumb stick up then down. You will hear two beeps
- b. The ON/OFF buttons on both devices will then change to solid red once paired
- c. The LED lights underneath the drone will also flash. Orange indicates the head of the drone, while green indicates the tail of the drone

Engaging the Propellers

To start the propellers and fly the drone, there are three methods that can be used, however each operate slightly differently:

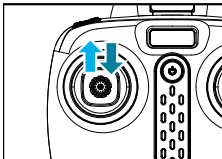

Method 1 - Push the left thumb stick up to the highest point and then allow the thumb stick to reset to the centre

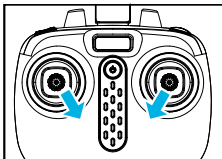

Method 2 – Move the left and right thumb sticks inwards and hold for 1-2 seconds as illustrated

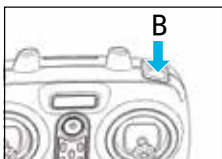

Method 3 – Press the B Button. This will start the propellers and raise the drone automatically off the ground.

After Sales Support

 44 800 496 9698

 customercare@balcolifestyle.com

Model Number HE180066

Operation

3.2 Switching OFF the Propellers & Drone

To power down the drone and its propellers, there are three methods that can be used.

Each method is different and should be used based on the situation at hand:

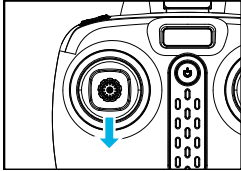

Method 1: Slow Shutdown - Push the left thumb stick down to the lowest level and hold for approximately 5 seconds until the drone has landed and powered down. In this method, the drone will slowly come back to the ground and then the propellers will power down. Use this function if you do not want the motor and propellers to cut out immediately

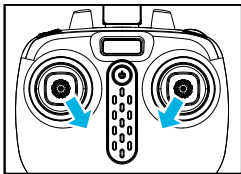

Method 2: Immediate Shut Down - Move the left and right thumb sticks inwards and hold for 1-2 seconds as illustrated to immediately shut down the motor and propellers. This method differs from methods 1 and 3 as the drone will not slowly land, the propellers will immediately shut off and the drone will fall to the ground.

NOTE: This method should only be used for emergency landings OR when the drone is close to the ground (approximately 30cm)



Method 3: Auto-Land – Press the B button on the top of the remote control to auto-land the drone. Like method 1, the drone will slowly come back to the ground and the propellers will power down

NOTE:

- In methods 1 and 3, the propellers will not immediately power down. If the drone is already close to the ground and you use one of these methods, you may need to use the thumb sticks to direct and control the drone as necessary until the propellers power down and the drone has landed
- To turn OFF the drone completely, press the ON/OFF button on both the drone and the remote control
- Never leave your drone unattended while powered ON

After Sales Support



44 800 496 9698



customercare@balcolifestyle.com

Model Number HE180066

Operation

3.3 Flying the Balco FPV HD Camera Drone

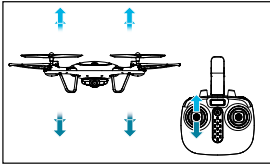

Hover Up & Down

Push the left thumb stick up or down to move the drone upwards or downwards

TIP: If you begin to lose control of the drone refer to the three methods outlined on page 15 to land your drone safely.

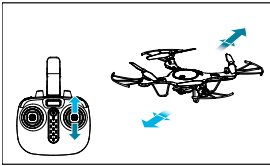

Forward & Backward

Push the right thumb stick up or down to move the drone forwards or backwards.

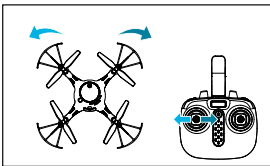

Turn Left & Right

Pull the left thumb stick left or right to turn the drone left or right.

NOTE: This does not move the drone sideways to the left or right

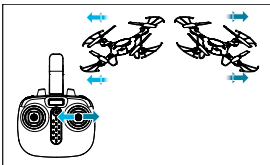

Fly Sideways

Pull the right thumb stick left or right to move the drone to the left or right. As illustrated, the drone will tilt in the direction you would like it to go to

NOTE:

- If the both the green and orange LEDs begin flashing quickly while you are flying the drone, this indicates the battery is running low. Land immediately on a level surface and recharge your battery as explained on page 12. If the battery is extremely low it will land automatically
- Do not fly again until the battery is fully charged

After Sales Support

 44 800 496 9698

 customercare@balcolifestyle.com

Model Number HE180066

Operation

3.4 Fine Tuning / Trimming

If you find the drone is veering in a particular direction, you may need to fine tune the control to keep the Balco FPV HD Camera Drone steady. This should only be done when there is no or very minimal wind.

While the drone is in the air, depress the left thumb stick (i.e. press the left thumbstick into its centre, don't move the thumbstick down) and at the same time use the right or left thumb stick as per the following instructions depending on the direction that needs fine tuning. Do not lift the left thumb stick until you have finished fine tuning.

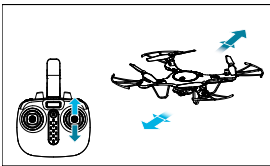

Forward/Backward Fine Tune

Depress the left thumb stick into its centre, move the right thumb stick up or down

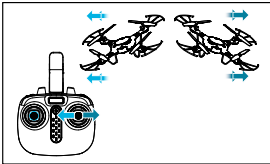

Left/Right Fine Tune

Depress the left thumb stick into its centre, move the right thumb stick to the left or right

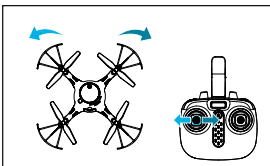

Turn Left/Right Fine Tune

Depress the left thumb stick into its centre, move the left thumb stick to left or right

NOTE:

- You may need to fine tune your drone multiple times during flight due to air flow conditions

Reset Trimming

In order to reset trimming, land the drone and then turn the remote control OFF. Then whilst depressing the left thumb stick, turn the remote control ON. The remote control will beep three times to confirm the trim has been reset.

Operation

3.5 Level Calibration

This feature allows you to calibrate the drone so that it does not start to tilt during flight.

Calibration should only be done before flight not during flight. To calibrate the drone:

- Place the drone on a level surface
- Press the left and right thumb sticks to the lower right corners and hold for 2-3 seconds. You will notice the drone LED lights will flash
- The level calibration will now be complete

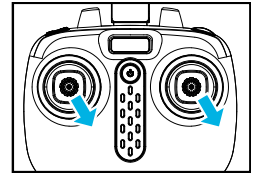

3.6 Speed Control

The Balco FPV HD Camera Drone can be operated in a low and a high-speed setting. When you turn on the drone, it will automatically be set to low speed. To change to high speed, depress the right thumb stick in towards its centre, you will hear two beeps. If you are in high speed and want to move to low speed, depress the right thumb stick again, you will hear one beep.

NOTE:

- You can adjust speed settings while the drone is in flight or while the drone is on the ground and paired
- The drone's default setting is low speed. If you change the speed to high and switch OFF the drone, it will default back to low when you go to turn the drone back ON at a later time. If you however land the drone without turning the drone OFF, then the drone will still be in high speed

3.7 360° Flip Stunt Feature

Once you are familiar with the basic flight operations, you can explore the 360° flip stunt feature.

- Fly the drone to a height of more than 3 metres
- Press the upper right corner button on the remote control and simultaneously push the right thumb stick in any direction to perform the 360-degree flip

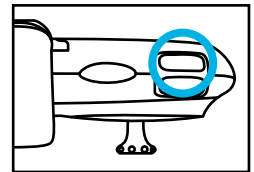

NOTE:

- Fully charge the battery before attempting the 360-degree flip. If the battery power is low, the drone will not be able to perform the 360-degree flip
- Make sure you allow enough space both above and below your drone before attempting to perform flips
- Never attempt tricks with bent or damaged propellers or guards

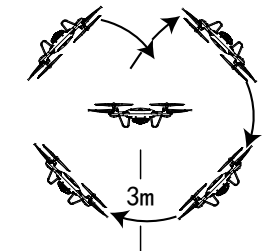

Operation

3.8 Hovering Height Adjustment

Once you have manoeuvred the drone up and down using the left thumb stick, the drone has an auto-hover feature which will allow the drone to stay at a specific height without having to control the left thumb stick.

3.9 Headless / Normal Modes

The drone can be operated in Headless and Normal Modes. Headless mode enables you to fly the drone without having to focus on the drone's orientation i.e. where the head of the drone is in relation to your position. This means that regardless of whether the head, one of the sides or the tail of the drone is facing you, moving sideways to the left will always be left for example.

In Normal Mode however, the drone's direction will be dependent upon the tail of the drone in relation to your position. For example, if the drone's tail is facing you and you manoeuvre it the left, the drone will move left. However, if the head of the drone is facing you and you perform the same manoeuvre, you will find the drone will move right.

To change to Headless Mode:

- a. During flight, depress the right thumb stick into its centre for approximately 2 seconds until you hear 8 beeps and the LED lights under the drone will flash every 4 seconds
- b. To change to normal mode, depress the right thumb stick into its centre for approximately 2 seconds and you will hear one long beep. In normal mode, the LED lights under the drone will not flash

NOTE:

- *Headless mode is great for beginners*
- *If you are operating the drone in Normal Mode, we recommend that you always start by having the drone's tail facing you therefore the head of the drone and camera should face away from you*
- *The drone's default setting will be in Normal Mode. If you change the drone to Headless Mode and switch OFF the drone, the drone will default back to Normal Mode. If you only land the drone and do not switch it OFF, it will remain in Headless Mode*
- *You can switch between Normal and Headless Modes both during flight and after you have paired the remote control and drone before flying*



Operation

3.10 Recalibrate the Balco FPV HD Camera Drone

In the event the drone begins to fly strangely OR after a major impact, you can recalibrate the direction by pushing the left and right thumb sticks for approximately 2 seconds to the far bottom left simultaneously. You will notice the drone's LED lights will flash indicating the drone has been reset.

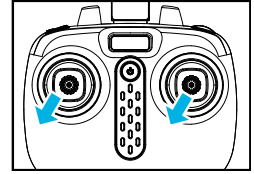

NOTE: You cannot recalibrate the drone during flight. It can only be recalibrated while ON and positioned on the ground. Please make sure the drone's tail is facing you

3.11 Capture Photos & Videos

Photos and videos can be captured either directly on your mobile device if connected to the FPV Application (see page 21 **Fly the Balco FPV HD Camera Drone using the 'Drone Go' App**) or using a MicroSD Card (not supplied)

- a. To take a photo, press the photo button on top left shoulder button of the remote control as illustrated on page 11 until you hear one beep
- b. To take a video, press the video button located on the bottom left shoulder button of the remote control (underneath the photo button) as illustrated on page 11, until you hear two beeps to indicate recording has started. To end recording, press the same button until you hear two beeps



NOTE: Make sure you have installed the camera onto the drone. For installation, refer to page 13

3.12 Replacing Parts

Eventually your propellers will most likely need to be replaced. Do not operate the Balco FPV HD Camera Drone with damaged propellers as you may suddenly lose control of the drone during flight. Follow the steps below to replace your drone's propellers:

- a. Position the drone on a level, horizontal surface, with the head facing forward as shown below.
- b. Determine which propellers need replacing and note the propeller warning text side (left or right) by checking the top of the propeller.
- c. Using a flat head screw driver, lift the cap to unsecure the propeller
- d. Replace the propeller with the same type (left or right), noted by an "A" or a "B" symbol



After Sales Support

44 800 496 9698



customercare@balcolifestyle.com

Model Number HE180066

Operation

- e. Screw in the replacement blade firmly
- f. When flying the drone after replacing the propellers, gently increase the throttle to check that the drone will remain stable when flying. If the incorrect propeller type is used, the drone will be unable to remain level

To purchase additional propellers or parts for your drone, visit balcolifestyle.com

3.13 Fly the Balco FPV HD Camera Drone using the 'Drone Go' App

The Balco FPV HD Camera Drone can be operated using the remote control and/or a smart phone.

To setup your smart phone:

- a. Download the drone application by using a QR code reader application and scanning the below QR codes or by searching in the App Store or Play Store for 'Drone Go'

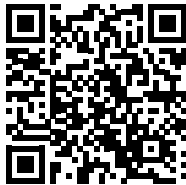

iOS App
(Version 8.0)

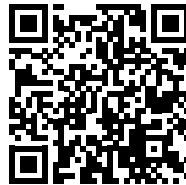

Android App
(Version 4.1)

- b. Download the application from the App Store or Google Play depending on your device
- c. Switch ON both the remote control and drone and pair them as per section 3.1
- d. Go to settings on your phone and turn on WiFi. In the WiFi Search list select "FPV_WIFI_****".
- e. Open the app, click the Start icon to enter the control interface.

For more information on the Drone FPV interface, see page 22

NOTE:

- We recommend using the remote control to fly the drone whilst using the App for photos, videos and FPV (First Person Viewing). Only advanced users should fly the drone using a mobile device without the remote control
- A full bar in the WiFi signal icon indicates the strongest possible signal
- If the remote control is ON and paired to the drone, you will not be able to fly the drone using your mobile device. You will only be able to take a photo or video
- To fly the drone using your phone, always turn the remote control OFF
- The control distance with your phone is up to 25 meters

After Sales Support



44 800 496 9698



customercare@balcolifestyle.com

Model Number HE180066

Operation

3.14 'Drone Go' Application Interface

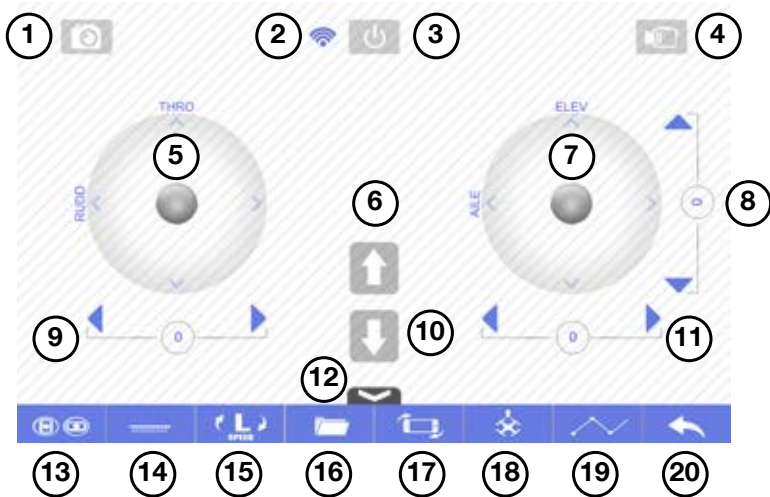

- | | |
|---|--|
| 1. Take Photo | 13. Show/Hide Thumbsticks |
| 2. WiFi Signal | 14. Level Calibration |
| 3. Engage/Switch off Propellers | 15. High/Low Speed Mode |
| 4. Take Video | 16. Check SD Card (SD Card not included) / Phone Memory |
| 5. Left Thumbstick | 17. Gravity Induction Mode - Uses phone movement to control drone rather than using thumbsticks |
| 6. Auto Take Off | 18. Headless Mode |
| 7. Right Thumbstick | 19. Waypoint Mode (see note below) |
| 8. Fine Tune - Forwards/Backwards | 20. Back |
| 9. Fine Tune - Turn Left/Right | |
| 10. Auto Land | |
| 11. Fine Tune - Move Sideways Left/Right | |
| 12. Hide Toolbar | |

NOTE:

- For information regarding thumbstick use, refer to remote control instructions on page 16
- When fine tuning there is no need to depress the left thumbstick with the App. Simply press the arrows
- Using the 'Drone Go' App allows you to view the camera in real time using First Person View
- The waypoint function allows you to draw a pathway on the right hand side of the application, for the drone to follow. For example, a straight line, circle or triangle could be drawn which the drone will follow. Please note that this waypoint function does not use GPS, this means that the drone's pathway can be affected by airflow and will not be as accurate as a GPS controlled drone.
- If in Normal Mode (i.e. Headless Mode is off), take note of the head of the drone and therefore the direction the drone will take

After Sales Support







44 800 496 9698



customercare@balcolifestyle.com

Model Number HE180066

FAQs

Question	Solution
My Balco FPV HD Camera Drone didn't pair with my remote control	At times the Balco FPV HD Camera Drone may fail to pair with the remote control. Attempt to pair again, ensuring the drone is resting on a level surface.
My Balco FPV HD Camera Drone isn't responding	Check that the battery in the Balco FPV HD Camera Drone is still charged. Also check that the remote control batteries are still charged.
My Balco FPV HD Camera Drone is slow to respond	Ensure that the remote control batteries are still charged. There may also be interference from a similar frequency nearby. Try using the Balco FPV HD Camera Drone in a different location, away from other radio controlled devices.
Not flying straight or spinning	Follow the steps in 'Fine Tuning' to configure the Balco FPV HD Camera Drone correctly. If unsuccessful, try following the steps in 'Recalibrate the Balco FPV HD Camera Drone' on page 20.
How do I see photos and pictures on my phone?	Open the 'Drone Go' app > Start >  >  or  > Tap photo or video to view
How do I transfer photos to my camera roll in iOS?	Open the 'Drone Go' app > START >  >  or  > SELECT > Tap photo or video to transfer > ADD TO ALBUM
How do I transfer photos or videos to my computer in iOS?	First transfer photos or videos to your camera roll using the instructions above, then download to your computer per your devices instructions.
How do I transfer photos or videos to my computer in Android?	Connect your Android mobile to your computer. Navigate to the root > DRONE directory to find your photos and videos. Copy them to your computer.



BALCO™